

## OPTIONAL ACCESSORIES

RedLite™ II



Art No. TMS035B (Black)  
TMS035W (White)

Journey Trail TX Yoke  
with SlideLock

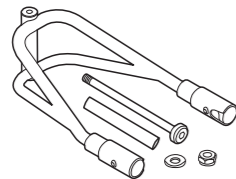

Art no. TRK-TTRSP10

Journey DryBag

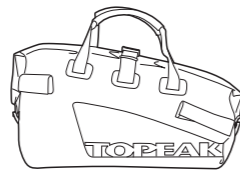

Art no. TRK-TTRSP02

## WARRANTY

2-year Warranty: All mechanical components against manufacturer defects only.

### Warranty Claim Requirements

To obtain warranty service, you must have your original sales receipt. Items returned without a sales receipt will assume that the warranty begins on the date of manufacture. All warranties will be void if the Journey Trailer or DryBag is damaged due to user abuse, system alteration, modification, or used in any way not intended as described in this user's guide.

\* The specifications and design are subject to change without notice.

Please contact your Topeak dealer with any questions.

For USA customer service, call : 1-800-250-3068

[www.topeak.com](http://www.topeak.com)

Copyright © Topeak, Inc. 2018

TTR-TX\_M\_EN\_201809



## JOURNEY TRAILER TX AND DRYBAG

PREPARE TO RIDE

EN

- Maximum Load: **32 kgs/ 70 lbs**
- Maximum Capacity: **65.3 L / 3980 ci**
- Please read all instructions before first use. Installation procedures follow in this manual.

Compatible with 12mm rear thru-axes under 180mm in length with 1, 1.5 or 1.75mm thread pitch and Shimano® ALFINE 11 & 8, NEXUS INTER-8 internal gear hubs. (Optional hardware required. Purchase from Topeak distributors or dealers near you.)

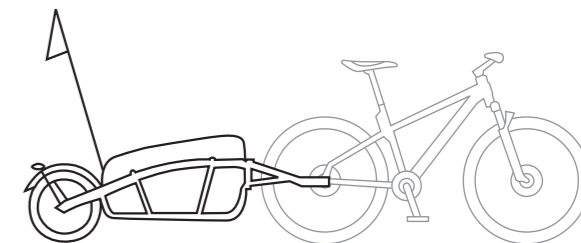



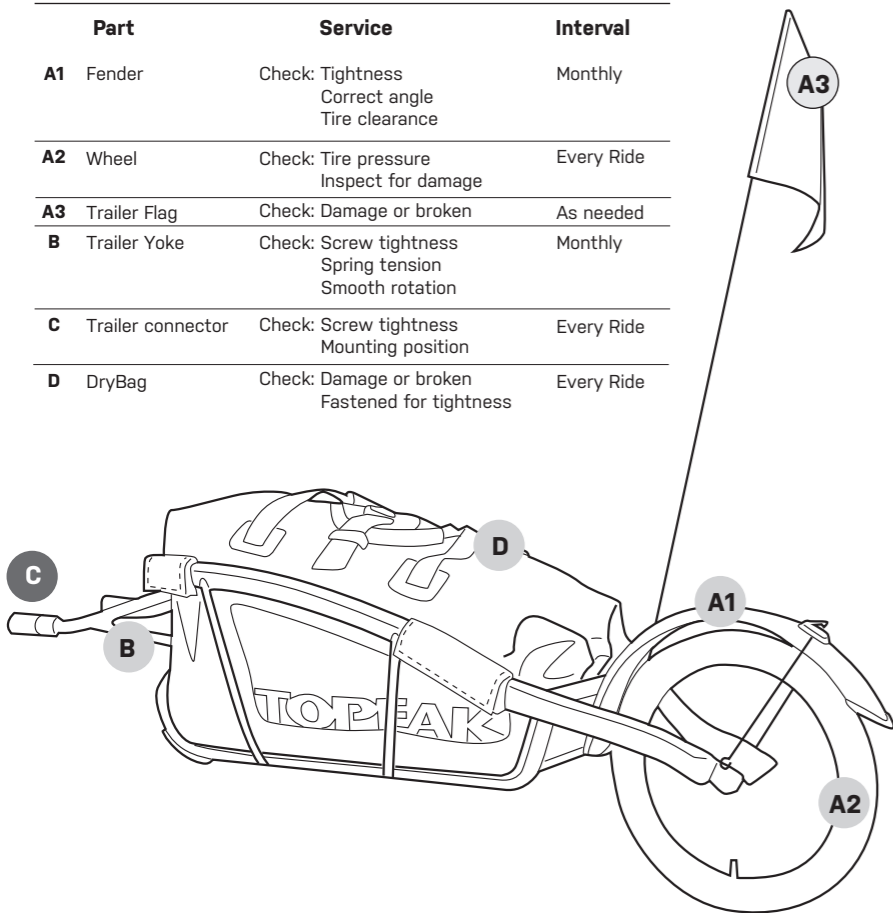

## MAINTENANCE SCHEDULE

Part	Service	Interval
<b>A1</b> Fender	Check: Tightness Correct angle Tire clearance	Monthly
<b>A2</b> Wheel	Check: Tire pressure Inspect for damage	Every Ride
<b>A3</b> Trailer Flag	Check: Damage or broken	As needed
<b>B</b> Trailer Yoke	Check: Screw tightness Spring tension Smooth rotation	Monthly
<b>C</b> Trailer connector	Check: Screw tightness Mounting position	Every Ride
<b>D</b> DryBag	Check: Damage or broken Fastened for tightness	Every Ride

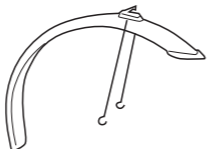

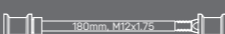
Your Journey Trailer should includes the following parts:

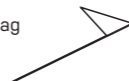
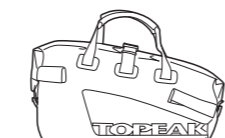
<b>A</b>	<p><b>A1. Trailer Fender</b></p>  <p>Washer 3 pcs    Screws 3 pcs</p>	<p><b>C</b> Optional and required parts</p> <p><b>C1</b> Journey Trail TX Axle Kit-P10 Art no. TTR-TXAK-P10</p>  <p>Washers (7 pcs)</p> <hr/> <p>Journey Trail TX Axle Kit-P15 Art no. TTR-TXAK-P15</p>  <p>Washers (7 pcs)</p> <hr/> <p>Journey Trail TX Axle Kit-P175 Art no. TTR-TXAK-P175</p>  <p>Washers (7 pcs)</p>
<b>B</b>	<p><b>A2. Quick Release 16" wheel</b></p> 	<p><b>C2</b> Journey Trail TX Nut Kit Art no. TTR-TXNK-IGH</p>  <p>Washers (6 pcs)</p>
<b>D</b>	<p><b>A3. Trailer Flag</b></p> 	<p><b>D</b> Journey DryBag</p> 

\* Tools Required: 4/5/6mm Allen key, 10mm open end wrench

## A. TRAILER FENDER AND WHEEL ASSEMBLY

### A-1 Installation of Trailer Fender



### A-2 Installation of Quick Release 16" wheel

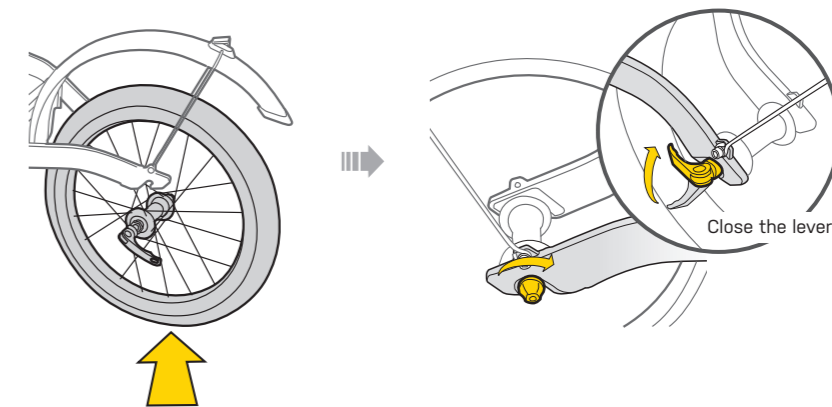

## B. TRAILER YOKE ASSEMBLY

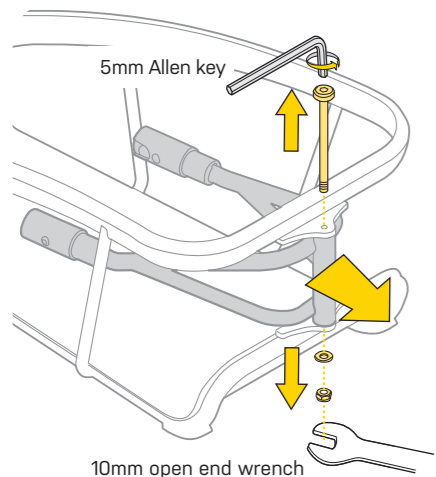

Release the axle and remove the Trailer Yoke

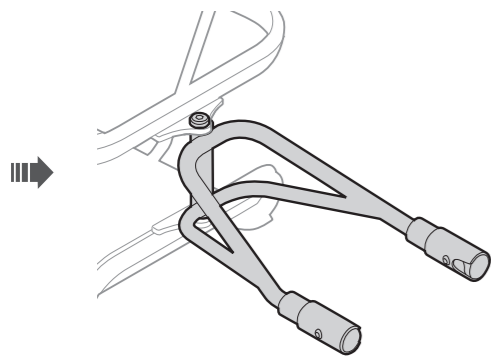

4

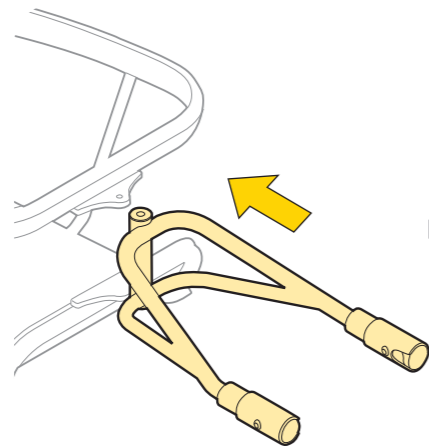

Rotate the Trailer Yoke

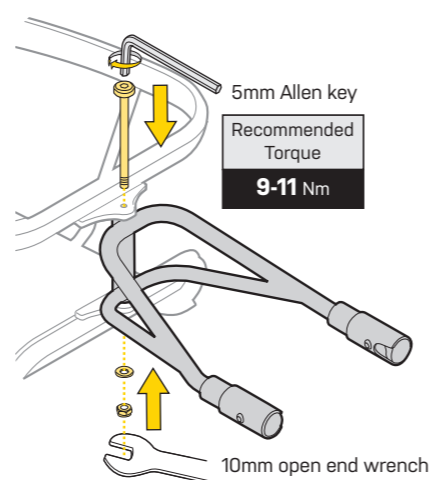

Reinstall the Trailer Yoke as shown

## C. MOUNTING TRAILER TO THE BIKE

### C-1 Thru-axle version

Compatible with 12mm rear thru-axles under 180mm in length

Three thread pitches available : 1.0, 1.5 and 1.75 mm

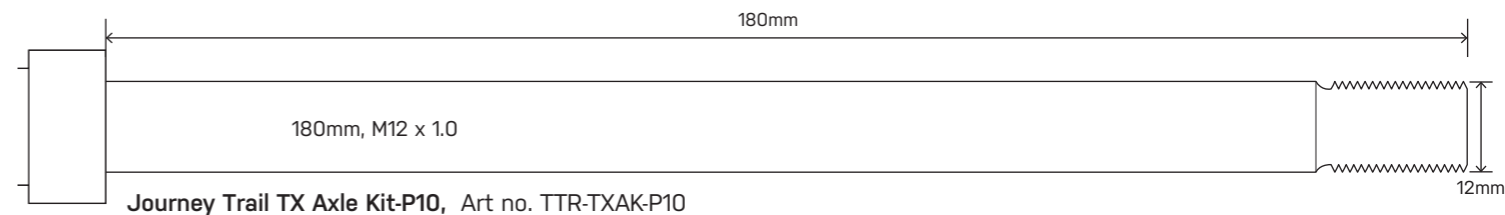
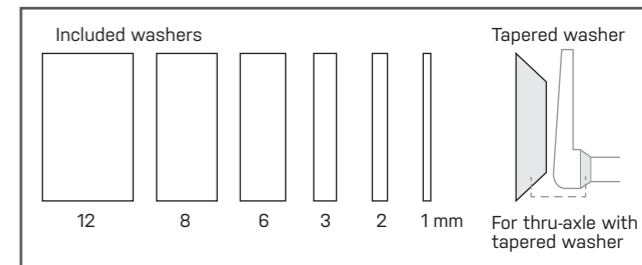

Journey Trail TX Axle Kit-P10, Art no. TTR-TXAK-P10



Journey Trail TX Axle Kit-P15, Art no. TTR-TXAK-P15

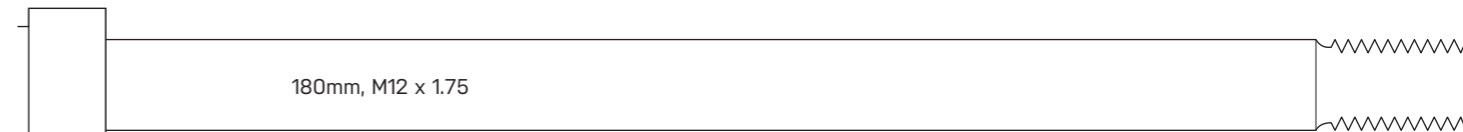

Journey Trail TX Axle Kit-P175, Art no. TTR-TXAK-P175

5

1. Choose the correct thread pitch, 1.0 / 1.5 / 1.75 mm, to match your thru-axe and order it from Topeak distributors or dealers near you.

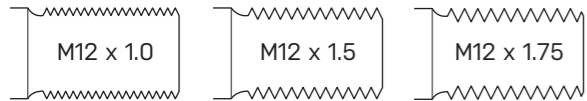

2. Compare with your thru-axe and choose the proper washers to add on Topeak thru-axe you have purchased as close to the length of your thru-axe as possible.

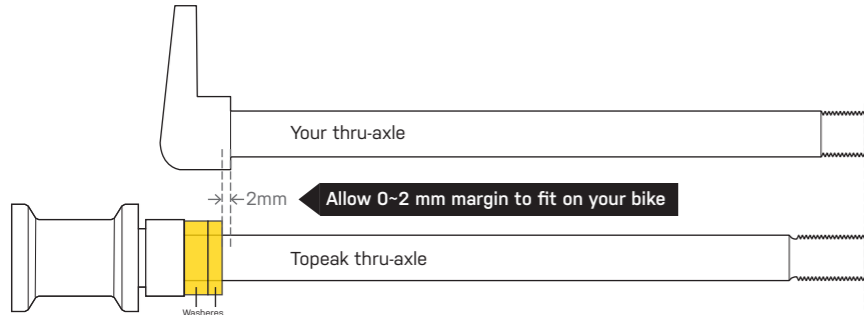

**Proper washer added for your bike**

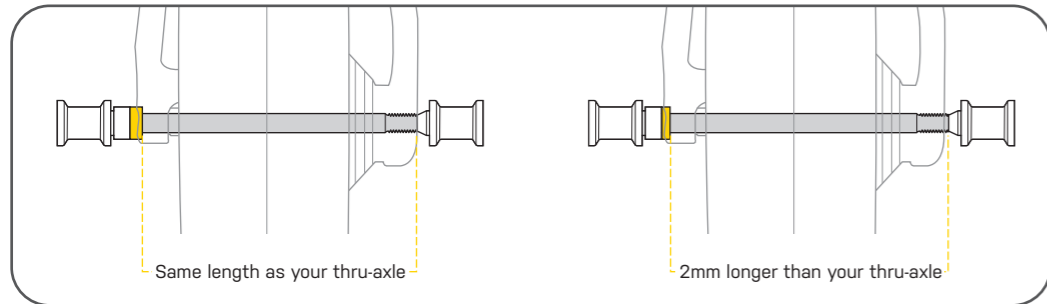

**STEP 1 Remove rear thru-axe from rear wheel and install the Trail TX axle**

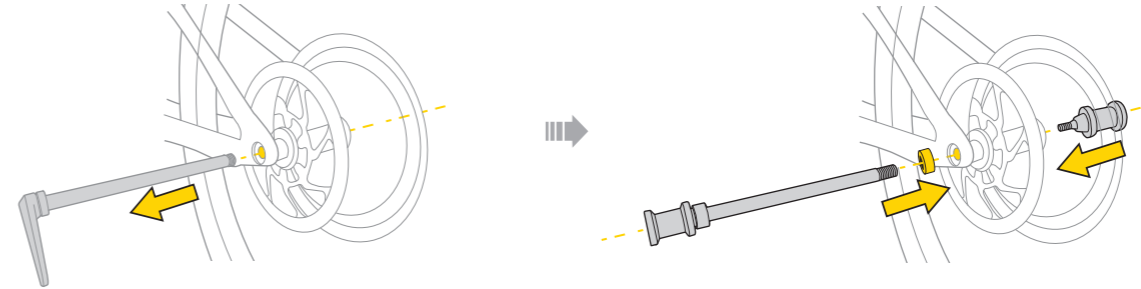

**STEP 2**

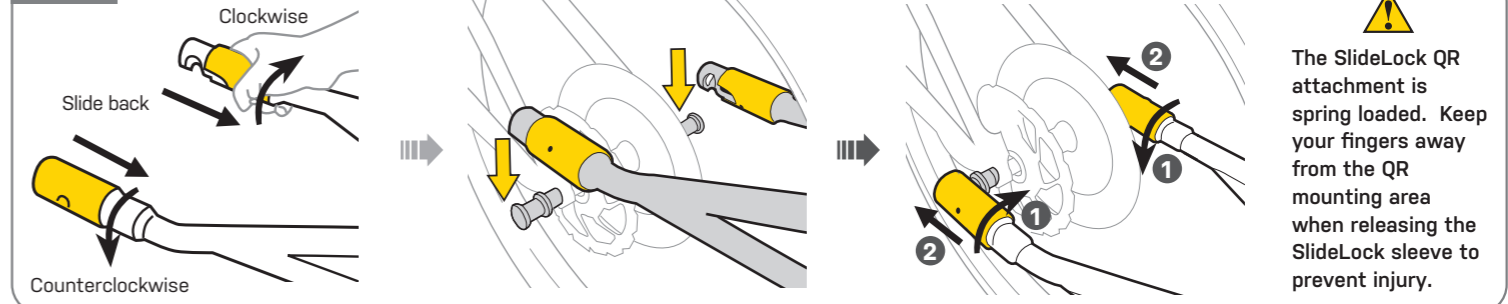

## C-2 Internal Gear Hub version

Compatible with Shimano® ALFINE 11, 8 and NEXUS INTER-8

Included washers

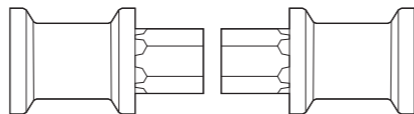
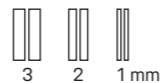

### STEP 1 Remove the Internal gear hub axle nuts from rear wheel and Install the Axle Nut Anchors

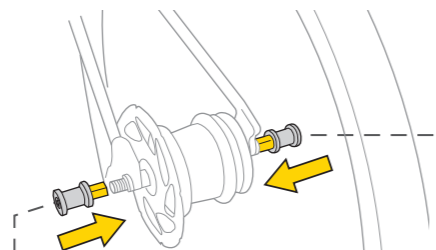
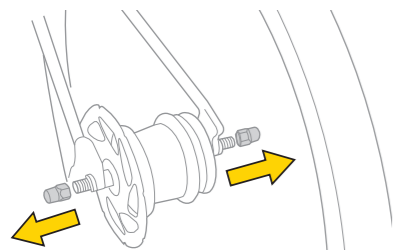

#### Axle Nut Anchor

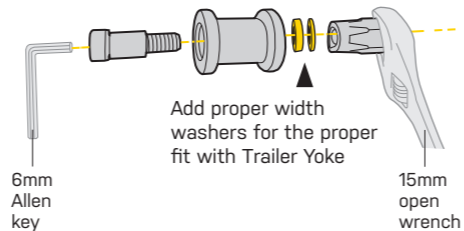

Add proper width washers for the proper fit with Trailer Yoke

Recommended Torque for Anchor Bolt

12-15 Nm

Recommended Torque for Anchor Nut

40 Nm

### STEP 2

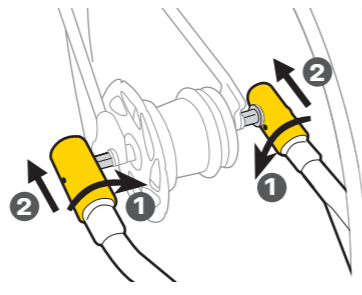
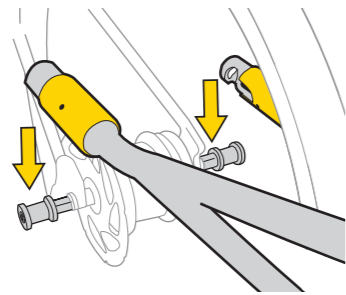
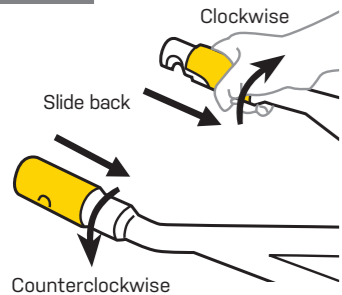

The SlideLock QR attachment is spring loaded. Keep your fingers away from the QR mounting area when releasing the SlideLock sleeve to prevent injury.

## D. JOURNEY DRYBAG ASSEMBLY

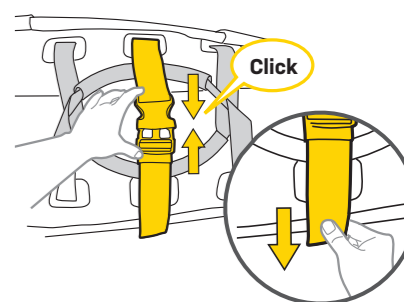
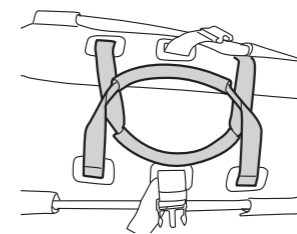
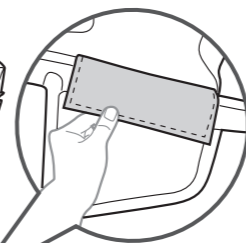
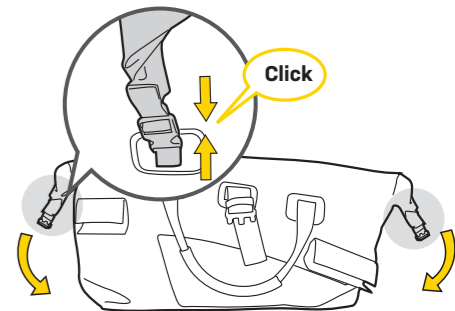
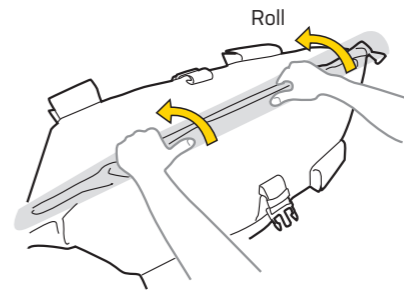
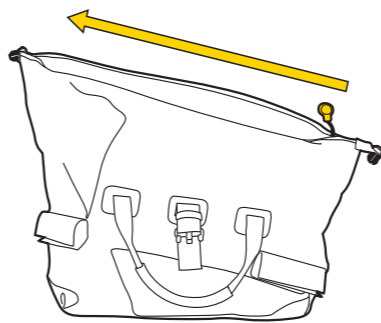

Pull down to fasten the strap

### IMPORTANT NOTE

- Make sure all sharp objects are covered to prevent punctures to the DryBag.
- Place heavier objects towards the bottom for maximum stability.

## ⚠ IMPORTANT NOTES ⚠

1. Never park your bike and trailer using the bike's kickstand. The added trailer weight cannot be supported correctly and may cause damage.
2. Make sure to park your bike and trailer on level ground. We do not recommend parking on grass, loose dirt, gravel, uneven or soft surfaces.

### Parking Tips

Align the rear wheel and trailer approximately 120 degrees (see inset diagram) and turn the front wheel approximately 90 degrees to the bike (see inset diagram) to stabilize and park. The trailer frame will touch the ground after parking (as shown)

### Un-Parking Tips

Place one hand on the handlebar and the other on the seat while walking forward to "un-park" your bike as the trailer will stabilize in the horizontal position.



Trailer will touch the ground in this area after parking the bike and trailer as shown.

## ⚠ WARNING

1. Maximum weight capacity: **32 kgs (70 lbs)**
2. Topeak Trailer fits on bikes with 26", 700C or 29" wheels which with 12mm rear thru-axes under 180mm in length with 1, 1.5 or 1.75mm thread pitch and Shimano® ALFINE 11 & 8, NEXUS INTER-8 internal gear hub bikes.
3. Topeak Journey Trailer is intended to carry cargo only. Do not carry children or live animals.
4. Make sure your cargo is placed securely in trailer. Shifting loads can adversely affect bicycle handling and result in loss of control.
5. **SPEED LIMIT: 30 kph (17 mph)**. Speed wobbles (and loss of control) can occur if speed limit is exceeded.
6. Keep the cargo center of gravity low.
7. Generally, other road users do not expect bicycles to be pulling trailers. Use the included trailer flag for added safety and visibility.
8. Check that the tail light is properly installed before riding (optional or required). Contact your appropriate government agency to learn of any lighting requirements in your region.
9. When passing a cyclist or pedestrian, remember that you are approximately 4.5 feet (1.40m) longer when pulling your trailer.
10. Always allow extra stopping distance when riding with your trailer.
11. When riding in wet conditions use extreme caution and allow even more distance for braking.
12. We strongly recommend that you cautiously test ride the bike (braking and turning) with a full test load (70lbs/32kgs) on wet, sandy or gravel covered surfaces to get accustomed to the change in handling characteristics before embarking on a trip.

## REQUIRED OPTIONAL HARDWARE

Journey Trail TX Axle Kit-P10



Art no. TTR-TXAK-P10

Journey Trail TX Axle Kit-P15



Art no. TTR-TXAK-P15

Journey Trail TX Axle Kit-P175



Art no. TTR-TXAK-P175

Journey Trail TX Nut Kit



Art no. TTR-TXNK-IGH